

BAREBONE XPC slim XH410G

FOR HIGHEST PERFORMANCE PER CM³ – 3-LITRE PC SUPPORTS SINGLE-SLOT PCIe CARDS

The Shuttle XPC slim Barebone XH410G is a 3-litre PC to house one single-slot PCI-Express expansion cards. Together with an LGA 1200 Intel Core desktop processor of the Comet Lake range, this platform is perfectly suited for many professional applications where performance, flexibility and a compact form factor matter. This includes video wall presentations, graphics workstations, media capturing, surveillance, POS, POI as well as network and industrial applications. Even mid-range gaming is possible.

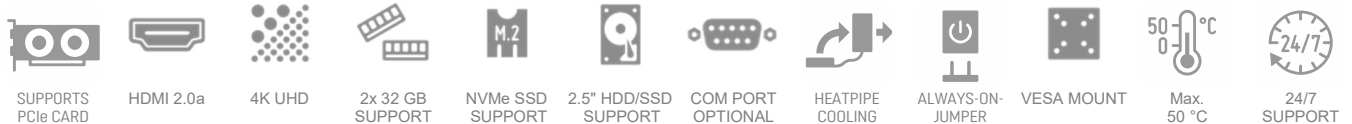

SLIM DESIGN

- Robust 3-litre steel chassis, black
- Dimensions: 250 x 200 x 78.5 mm (LWH)
- Including VESA mount (75/100 mm)
- Supports 24/7 Non-stop Operation
- Operating temperature: 0~50 °C (non-condensing)

OPERATING SYSTEM

- An operating system is not included
- Supports Windows 10/11 and Linux (64-bit)

PROCESSOR SUPPORT

- Socket LGA1200 supports 10th-gen Intel Core i9/i7/i5/i3, Pentium Gold und Celeron processors, codenamed "Comet Lake-S", max. 65W TDP
- Includes heatpipe cooling system with two fans

PCIe X16 Slot

- 1x PCI Express X16 v3.0 slot
- Supports single-slot expansion cards with max. 208 x 120 x 30 mm in size and max. 75 W TDP
- Onboard 5V auxiliary voltage (max. 2 A) with 4-pin Molex adapter cable

CHIPSET

- Intel H410 Chipset

MEMORY SUPPORT

- 2x 260-pin SO-DIMM slot
- Supports DDR4-2933 /2666
- max. 2x 32 GB

STORAGE – SATA / M.2

- 1x 2.5" bay for SATA hard disk or SSD, max. 9.5 mm
- 1x M.2-2280M slot (supports PCIe x4 NVMe or SATA)
- 1x M.2-2230AE for an optional WLAN card

CONNECTORS

- HDMI 2.0a
- D-Sub VGA
- 4x USB 3.2 Gen1
- 4x USB 2.0
- 1x USB 2.0 internal port für USB stick
- 2x audio (line out, mic)
- Intel Gigabit LAN (RJ45)
- Connector for external power button
- "Always-On" jumper
- DC input

POWER SUPPLY

- External 180 W / 19.5 V power adapter

OPTIONAL ACCESSORIES

- WLAN Module (WLN-M)
- Vertical Stand (PS01)
- RS232 COM port (PCP11)
- Cable for external power button (CXP01)



PRODUCT FEATURES



The slim chassis - a clean and modern look

Shuttle has always placed great emphasis on the interior and exterior aesthetics of their Mini-PCs with the belief that a good blend of style and form factor allows the Mini-PC to be attractive, versatile and work well in almost any environment. The XH410G was designed just like that and shines in a clean and modern appearance. The front panel connectors are easy to access for daily use, and this tiny tot barely stands at 7.85 cm in height.



Supports extended temperature range and 24/7 operation

The Shuttle XPC slim Barebone XH410G is officially approved for 24/7 permanent operation. Thanks to its efficient cooling, this PC runs highly reliable making it perfectly suitable for digital signage and POI/POS applications - even at ambient temperatures of up to 50 °C (non-condensing). **Caution:** For high ambient temperatures over 40 °C we strongly recommend to use SSDs.



VESA mount included

With the supplied VESA mount you can easily attach the XH410G to the backside of an appropriate display, to a VESA arm or just to the wall. It is compatible with 75x75 mm and 100x100 mm VESA standards.



One M.2-Slot for SSD cards

The M.2-2280 slot supports one M.2 SSD storage card with NVMe PCIe or SATA interface. Type 2280 means, it supports the usual M.2 cards with a width of 22 mm and a length of 80 mm, but also 2242 and 2260 standard cards are supported.



Supports 10th Generation Intel® Core™ processors

"Comet Lake-S" is the codename for Intel's 10th Generation of Intel® Core™ Desktop Processors for socket LGA1200 introduced in 2020 along with the 400-Series chipsets. The 10000 series processors feature up to 10 cores and 20 threads and 20 MB of cache memory. With an optimal balance of frequency, cores and threads, these processors help supercharge Shuttle XPCs for maximum productivity in professional and mainstream applications.

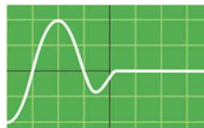

Power on after Power fail

The BIOS setup provides a "Power-On after Power Fail" function that can be found under "Power Management Configuration". As the name indicates, this function determines the PC's behaviour after power failure: (1) unconditional power on, (2) restore former status (3), keep system turned off (4), Power-On by LAN or (5) Power-On by Real-Time-Clock. As a matter of the nature of this function, it may fail after short power failures. This is why the XH410G also comes with a hardware-based solution. By removing Jumper JP1, the system will start unconditionally once power is applied.



Low noise thanks to heatpipe cooling system

An active dual-fan heatpipe cooling system ensures whisper-quiet operation and system stability. A heatpipe is a hollow tube containing a liquid to transfer heat. As the liquid evaporates, it carries heat to the cool end, where it condenses and then runs back to the hot end. Heatpipes have a much higher thermal conductivity than solid materials. Please keep the vent holes clear.



External power button by separate remote line

If, because of space constraints (e.g. in case of fixed installation), the machine cannot be switched on by pressing the front power button, it can be powered on by a separate remote line. You will find an appropriate four-pin connector at the back panel of the XH410G (pitch 2.54 mm). Furthermore, this connector provides a Clear CMOS function and +5V DC voltage supply for external devices.

+5V voltage (2) (4) Power Button
Clear CMOS (1) (3) Ground



4K Display support

The XH410G features one HDMI 2.0a video output for at 4K (3840 x 2160 / 2160p) high resolution at 60 Hz frames per second. Furthermore, the XH410G has a D-Sub/VGA port.

REQUIRED COMPONENTS

The following components need to be added to make it a fully-configured Mini PC

Shuttle XPC slim Barebone XH410G

Top view:



Bottom view:



LGA1200 Processor

Intel Core Gen 10 "Comet Lake-S"
Core i9 / i7 / i5 / i3, Pentium Gold or Celeron
TDP max. 65 W



Memory Modules

Up to two DDR4-2666/2933
SO-DIMM memory modules
max. 32 GB each



M.2 SSD

M.2-2280/2260/2242
SSD storage (SATA or PCIe/NVMe)



Graphics Card

Single Slot, PCI-Express X16, max. 75 W TDP
Dimensions: max. 208 mm x 120 mm x 30 mm



USB-Stick

USB 2.0, Dimensions max. 11.5 mm x 28 mm x 88 mm



2.5" Storage Drive

SATA hard disk or Solid State Disk (SSD)
(max. height: 9.5 mm)



Operating System

Windows 10/11 or Linux (64-bit only)

OPTIONAL ACCESSORIES FROM SHUTTLE



COM-Port-Adapter **PCP11**

To add a COM-Port (RS232) in the back panel.



Cable **CXP01**

Cable for external push button switch (without button)



WLAN-Accessory **WLN-M**

M.2-2230 card supports IEEE 802.11 b/g/n/ac and BT including 2 antennas



Vertical Stand **PS01**

for the vertical operation

EXAMPLES WITH EXPANSION CARDS



Despite its compact dimensions, the Shuttle XPC slim Barebone XH410G sports a full-size PCI-Express-X16 slot for single-slot cards not exceeding 208 mm (length), 120 mm (height) and 30 mm (width) and max. 75 W power consumption. At the same time, other powerful PC components such as an Intel Core i9 processor or 64 GB RAM are supported. This makes it particularly versatile in use which often asked for a bigger PC in the past.

Photo: Shuttle XPC slim Barebone XH410G with powerful graphics card installed.

Including 4-pin Molex connector with 5V/2A auxiliary voltage for special expansion card:



EXPANSION CARD	POSSIBLE APPLICATIONS
Gaming Graphics Card e.g. INNO3D GeForce GTX 1650 Single Slot 4GB GDDR5, HDMI, 2x DP	<ul style="list-style-type: none"> • Gaming PC • 3D Workstation
Multi-port Graphics Card e.g. AMD FirePro W600 or Matrox C680 with 6x Mini-DisplayPort	<ul style="list-style-type: none"> • Visualisation for Control Rooms • Surveillance and Security • Digital Signage with Video Wall • Information Display (POI)
CAD Graphics Card e.g. NVIDIA Quadro P2200	<ul style="list-style-type: none"> • CAD Applications • Content Creation • 3D Workstation
Video Capture Card e.g. with 4x SDI/BNC	<ul style="list-style-type: none"> • Multi-channel Capture System
Special Network Card e.g. Multiport or 10 Gbps	<ul style="list-style-type: none"> • Proxy and Firewall Applications • Intranet Server
Fieldbus Card e.g. EtherCAT, Profibus, CAN, Modbus, etc.	<ul style="list-style-type: none"> • Industry Automation • Conveyor Technology • Building Automation
Multi I/O Card e.g. 8x COM-Port, DA/AD converter, general-purpose input/output (GPIO)	<ul style="list-style-type: none"> • Point of Sales (POS) • Vending Machine • Automation / Control System
Receiver Card e.g. for SAT, DVB-T2, Cable	<ul style="list-style-type: none"> • Home Entertainment

Front and Back Panel

Front panel



1. 2x USB 3.2 Gen 1 port
2. 2x USB 2.0 port
3. Microphone input
4. Headphones output
5. Power button with Power LED indicator
6. LED indicator for storage activity

Back panel



7. 2x Thumbscrew
8. 2x WLAN perforation
9. Hole for Kensington Lock
10. PCI-Express X16 expansion slot
11. Perforation for optional COM port
12. HDMI 2.0a port
13. D-Sub VGA port
14. RJ45 Gigabit LAN port
15. 2x USB 3.2 Gen 1 port
16. 2x USB 2.0 port
17. DC-in connector for power adapter
18. 4-pin connector (2.54 mm pitch) for external power button, Clear CMOS button and 5V DC voltage

Top View

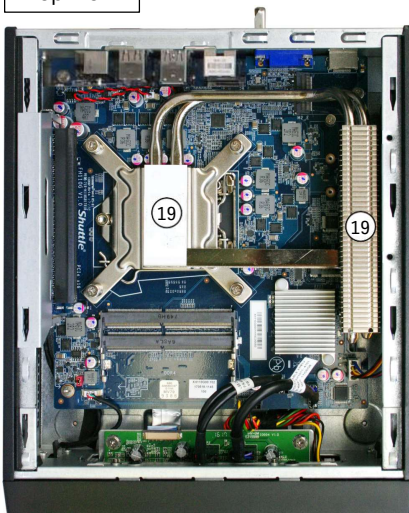

Bottom View



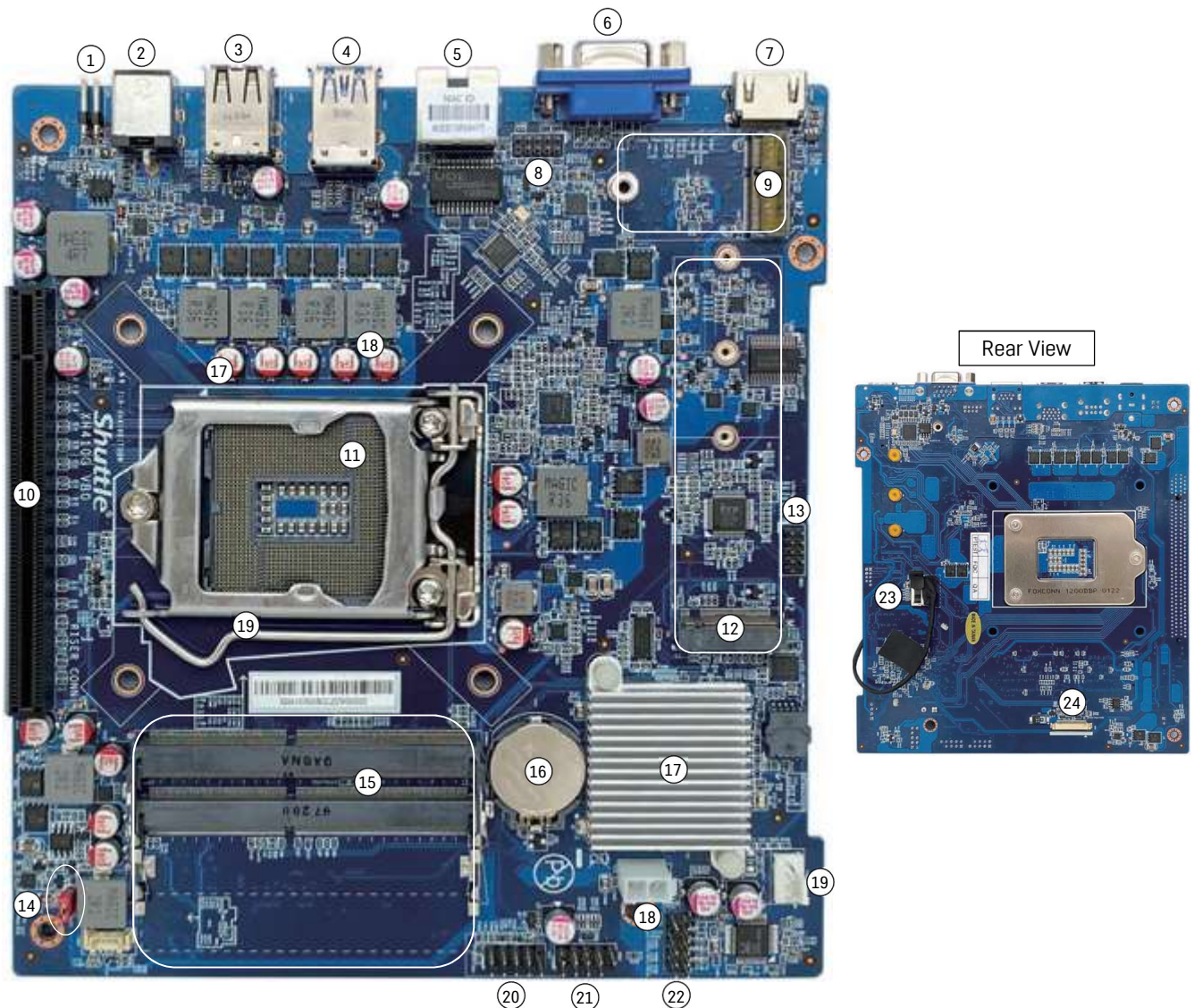

19. Installed heatpipe cooling system
20. Internal slot for USB 2.0 stick
21. Storage bay for 2.5" drive with SATA port

Mainboard



- | | |
|---|--|
| <ol style="list-style-type: none"> 1. 4-pin connector (2.54 mm pitch) for external power button, Clear CMOS button and 5V DC voltage 2. DC-in connector for power adapter 3. 2x USB 2.0 port 4. 2x USB 3.2 Gen 1 port 5. RJ45 Gigabit LAN port 6. D-Sub VGA port 7. HDMI 2.0a port 8. Onboard COM port supports RS232 9. M.2-2230E slot for WLAN card 10. PCI-Express X16 slot 11. LGA1200 processor socket 12. M.2-2280M slot for SSD card | <ol style="list-style-type: none"> 13. Debug header (reserved) 14. Always-Power-On jumper 15. 2x SO-DIMM memory slot 16. CMOS battery 17. Intel H410 chipset with heat sink 18. 5V power supply connector 19. 4-pin connector for cooling fan 20. Front panel power button and LED connector 21. Front panel USB 2.0 connector 22. Front panel Audio connector 23. SATA v3.0 connector 24. Front panel USB 3.0 connector |
|---|--|

Shuttle Product Comparison: XH110G versus XH410G

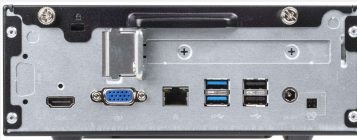
MODEL	XH110G	XH410G
Processor Support	6 th / 7 th Gen. Intel Core Processors "Skylake-S" & "Kaby Lake-S" Socket LGA1151, TDP max. 65W	10 th Gen. Intel Core Processors "Comet Lake-S" Socket LGA1200, TDP max. 65W
Operating System Support	Windows 10 & Linux – 64-bit Windows 7 with "Skylake" CPU only	Windows 10/11 & Linux – 64-bit
Chipset	Intel H110	Intel H410
Memory (max.)	2x 16 GB DDR4-2133/2400 SO-DIMM (260 pins)	2x 32 GB DDR4-2666/2933 SO-DIMM (260 pins)
Drive Bays	1x 2.5" bay (SATA v3.0) Max. height: 9.5 mm	1x 2.5" bay (SATA v3.0) Max. 9.5 mm height
PCI-Express Slot(s)	Single Slot: 1x PCI-Express v3.0 X16 Max. length/width: 208/30 mm Max. TDP: 75 W	Single Slot: 1x PCI-Express v3.0 X16 Max. length/width: 208/30 mm Max. TDP: 75 W
M.2 Slots	M.2-2280M (for PCIe or SATA SSDs) M.2-2230E (for WLAN modules)	M.2-2280M (for PCIe or SATA SSDs) M.2-2230E (for WLAN modules)
Front Panel Ports	2x USB 3.2 Gen 1 2x USB 2.0 2x Audio Power-Button Power-LED, HDD-LED	2x USB 3.2 Gen 1 2x USB 2.0 2x Audio Power-Button Power-LED, HDD-LED
Back Panel Ports	HDMI 1.4b + D-Sub/VGA 4x USB 2.0 Gigabit LAN DC input Clear CMOS button	HDMI 2.0a + D-Sub/VGA 2x USB 3.2 Gen 1 + 2x USB 2.0 Gigabit LAN DC input Connector for ext. Power Button Optional RS232 COM port
Internal Ports and Jumpers	USB 2.0 Type A (for USB stick) Always-power-on-Jumper	USB 2.0 Type A (for USB stick) Always-power-on-Jumper 5V power output connector (2-pin)
Power Adapter	180 W / 19.5 V	180 W / 19.5 V
Optional Accessories	WLAN kit (WLN-M) Vertical stand (PS01)	WLAN kit (WLN-M) Vertical stand (PS01) Power Button cable (CXP01) COM port adapter (PCP11)
Chassis Dimensions	25 x 20 x 7.85 cm (3.9 L)	25 x 20 x 7.85 cm (3.9 L)
Front View		
Back View		

SHUTTLE XPC SLIM BAREBONE XH410G – SPECIFICATIONS

CHASSIS	<p>Slim X-type chassis, colour: black</p> <p>Dimensions: 250 x 200 x 78.5 mm (LWH)</p> <p>Weight: 1.9 kg net, 3.0 kg gross</p> <p>Open front - no concealed front panel connectors</p> <p>Hole for Kensington Lock at the back panel</p>
OPERATING POSITION	<p>(1) horizontal on its feet</p> <p>(2) vertical with the optional stand (Accessory PS01)</p> <p>(3) vertical with the supplied VESA mount bracket</p>
POWER ADAPTER	<p>External 180 W power adapter (fanless)</p> <p>Input: 100~240 V AC, 50~60 Hz, max. 2.5 A</p> <p>Output: 19.5 V DC, max. 9.23 A, max. 180 W output wattage</p> <p>AC Connector with protective-earth contacts, cable length: 1.7 m</p> <p>DC Connector: 5.5 / 2.5 mm (outer/inner diameter)</p> <p>Dimensions: ca. 167 x 82 x 25.5 mm = 350 ml</p>
OPERATING SYSTEM	<p>This system comes without an operating system.</p> <p>It is compatible with Windows 10/11 and Linux (64-bit).</p>
PROCESSOR SUPPORT	<p>Processor Socket LGA1200</p> <p>Supports Intel Core i9 / i7 / i5 / i3, Pentium Gold and Celeron processors</p> <p>Supports 10th generation Intel Core processors, codenamed "Comet Lake-S" in 14 nm process technology</p> <p>Maximum supported processor power consumption (TDP) = 65 W</p> <p>Up to 10 CPU cores, 20 threads and 20 MB of L3 cache</p> <p>Does not support the unlock-function of Intel K-Series processors.</p> <p>The processor integrates PCI-Express, RAM controller and the graphics engine (Performance features depend on processor type [7])</p> <p>Please refer to the support list for detailed processor support information at global.shuttle.com.</p> <p>Not compatible with older Socket LGA 1151(v2) processors.</p>
PROCESSOR COOLING	<p>Processor cooling with heatpipe technology and two fans (60 mm)</p>
MAINBOARD / CHIPSET	<p>Mainboard in a Shuttle form factor, proprietary design for the XPC XH410G</p> <p>Chipset/Southbridge: Intel® H410</p> <p>Passive chipset cooling with heat sink</p> <p>The Northbridge is integrated in the processor.</p> <p>Solid Capacitors for sensitive areas provide excellent heat resistance for enhanced system durability</p>
BIOS	<p>AMI BIOS, SPI Interface, 16 MB Flash-EPR00M</p> <p>Supports Hardware Monitoring and watch dog functionality</p> <p>Supports Firmware-TPM (fTPM) v2.0 [8]</p> <p>Supports boot up from external USB flash memory</p> <p>Supports Unified Extensible Firmware Interface (UEFI)</p> <p>Supports power on after power failure [1]</p>
MEMORY SUPPORT	<p>2x SO-DIMM slot with 260 pins</p> <p>Supports DDR4-2666/2933 (PC4-21300/23466) SDRAM at 1.2 V</p> <p>Supports Dual Channel mode</p> <p>Supports a maximum of 32 GB per DIMM, maximum total size: 64 GB</p> <p>Supports two unbuffered DIMM modules (no ECC or registered)</p> <p>Note: The memory clock speed depends on the processor model. Intel Core i9 and i7 series processors support DDR4-2933 memory speed, while the other models support DDR4-2666.</p>
INTEGRATED GRAPHICS	<p>The features of the integrated Intel UHD graphics function depend on the processor type used. [7]</p> <p>Supports DirectX 12, OpenGL 4.5</p> <p>The PC features two video outputs:</p> <ul style="list-style-type: none"> - 1x HDMI v2.0a (digital) supports 1080p/60 and 2160p/60 - 1x D-Sub VGA (analog) supports 1080p/60 <p>The HDMI output supports displays with 4K Ultra HD resolution at 3840 x 2160 with 60 Hz refresh rate and support multi-channel digital audio over the same cable.</p> <p>Supports two independent displays with the integrated graphics function</p> <p>Supports Blu-ray (BD) playback with HDCP content protection [5]</p> <p>Hardware video decoding/encoding: H.264, H. 265 (8- and 10-bit, encoding via QuickSync), VP9 (10-bit VP9 can only be decoded)</p>

PCIe EXPANSION SLOT	<p>1x PCI-Express X16 v3.0 slot with installed 90° Riser Card</p> <p>The used expansion card must meet the following conditions:</p> <ul style="list-style-type: none"> - Maximum dimensions: 208 mm x 120 mm x 30 mm (Single Slot) - Maximum power consumption: 75 W - 5V (max. 2 A) auxiliary voltage via 4-pin Molex connector
AUDIO	<p>Audio Realtek® ALC 662 High-Definition Audio</p> <p>Two analog audio connectors (3.5 mm) at the front panel:</p> <p>(1) Microphone input</p> <p>(2) Headphones output (Line out)</p> <p>Digital 7.1 audio output: possible via the HDMI port</p>
GIGABIT LAN	<p>Gigabit LAN Controller: Intel i219LM</p> <p>Supports 10 / 100 / 1.000 MBit/s operation</p> <p>Supports WAKE ON LAN (WOL)</p> <p>Supports network boot by Preboot eXecution Environment (PXE)</p>
2.5" STORAGE BAY	<p>This system features one 2.5" drive bay which is accessible from the bottom of the housing.</p> <p>It supports one 2.5" / 6.35 cm hard disk or SSD with max. 9.5 mm height.</p> <p>The system includes a pre-installed data/power cable [3].</p> <p>The connector supports SATA III with max. 6 Gbps.</p>
M.2-2280M SLOT	<p>The M.2-2280 M slot provides the following interfaces:</p> <ul style="list-style-type: none"> - PCI-Express v2.0 X4 - SATA v3.0 (6 Gbps) <p>It supports M.2 cards with a width of 22 mm and a length of 42, 60 or 80 mm (type 2242, 2260, 2280) and M.2 SSDs with SATA or PCIe interface.</p>
M.2-2230E SLOT	<p>The M.2 2230 AE slot has the following interfaces:</p> <ul style="list-style-type: none"> - PCI-Express v2.0 X1 - USB 2.0 <p>It supports M.2 cards with a width of 22 mm and a length of 30 mm. This slot is intended for Wireless LAN (Wifi), Bluetooth, GSM/UMTS cards and other. A SATA interface for SSD cards is not available here.</p>
INTERNAL USB PORT	<p>This system features one internal USB port which is located behind the bottom cover of this PC.</p> <p>Connector: USB 2.0 Type A</p> <p>Maximum permitted size of the USB stick: 11.5 mm x 28 mm x 88 mm</p>
FRONT PANEL CONNECTORS	<p>1x Microphone input (3.5 mm)</p> <p>1x Headphones output (3.5 mm, line out)</p> <p>2x USB 3.2 Gen 1</p> <p>2x USB 2.0</p> <p>1x Power button with Power LED (blue)</p> <p>1x HDD LED (yellow)</p>
BACK PANEL CONNECTORS	<p>1x HDMI 2.0a digital audio/video output, supports screw lock [4]</p> <p>1x VGA / D-Sub analog video output</p> <p>2x USB 3.2 Gen 1</p> <p>2x USB 2.0</p> <p>1x GigaBit LAN (RJ45, Intel i219LM)</p> <p>1x DC-input connector for external power adapter (supports 19.5 V)</p> <p>1x 4-pin connector (2.54 mm pitch) supports:</p> <ul style="list-style-type: none"> - external power on button - Clear CMOS function - +5V DC voltage for external components <p>2x perforation for optional Wireless LAN antennas</p> <p>1x hole for Kensington Lock</p>
OTHER ONBOARD CONNECTORS	<p>2-pin onboard ATX connector with 5V (max. 2 A) output voltage with 4-pin Molex adapter cable</p> <p>Power-on-after-power-fail (hardware solution by jumper) [1]</p> <p>RS232 COM port (2x5-pin header, 2 mm pitch)</p> <p>Front connector for power button, LEDs, USBs, audio ports</p> <p>4-pin fan connectors (occupied by the CPU cooling system)</p> <p>4-pin USB 2.0 connector (occupied by the internal USB port)</p> <p>2x 5-pin debug port</p>

SUPPLIED ACCESSORIES	Multi-language installation guide (EN, DE, FR, ES, JP, KR, SC, TC) Driver DVD Bracket for one 2.5" drive with screws External power adapter with 1.7 m power cord with earthing contact VESA mount bracket (metal) supports 75x75 and 100x100 mm standard with four screws M4x10 Internal adapter cable with 4-pin Molex connector for 5V/2A auxiliary voltage Protector cap for the CPU socket (do not use if heatpipe or fan is mounted) CPU heatpipe cooling system with heatsink compound
OPTIONAL ACCESSORIES	PS01: Vertical stand WLN-M: WLAN module 802.11ac + BT4.0 with two external antennas [6] PCP11: Backpanel COM port adapter for RS232 serial interface CXP01: Adapter cable for external power button
ENVIRONMENTAL SPECIFICATIONS	Operating temperature range: 0~50 °C [2] Relative humidity range: 10~90 % (non-condensing)
CERTIFICATIONS / COMPLIANCE	EMI: CE, FCC, RCM, VCCI Safety: CB, ETL, BSMI Other: RoHS, Energy Star 5.0, ErP This device is classed as a technical information equipment (ITE) in class B and is intended for use in living room and office. The CE-mark approves the conformity by the EU directives: (1) 2004/108/EC relating to electromagnetic compatibility (EMC), (2) 2006/95/EC relating to Electrical Equipment designed for use within certain voltage limits (LVD), (3) 2009/125/EC relating to ecodesign requirements for energy-related products (ErP)

Footnotes:

[1] Power on after power fail

The BIOS setup provides a "Power-On after Power Fail" function that can be found under "Power Management Configuration". As the name indicates, this function determines the PC's behaviour after power failure: (1) unconditional power on, (2) restore former status or (3) keep system turned off. As a matter of the nature of this function, it may fail after short power failures. This is why the XH410G also comes with a hardware-based solution. By removing Jumper JP1 (located in a corner of the mainboard near the DIMM sockets) the system will start unconditionally once power is supplied.

[2] High ambient temperature

For high ambient temperature over 40 °C we strongly recommend to use SSDs instead of hard disk drives.

[3] Power connector for SATA drives

The supplied power cable for a SATA drive provides a voltage of 5 V. In very rare cases a 2.5" hard disk also requires a 12 V line. This is not supported.

[4] HDMI output supports DVI-D with optional adapter

[5] For Blu-ray playback appropriate software and an external Blu-ray drive is required (not included).

[6] Optional Wireless LAN module

Shuttle offers the optional accessory "WLN-M" which adds WLAN IEEE 802.11ac and Bluetooth 4.0 functionality. This kit consists of an M.2-2230 expansion card and two external antennas with appropriate cables.

[7] Intel processors without integrated graphics can be identified by their model name ending on "F", e.g. Core i7-10700F. When using this CPU, a graphics card is required.

[8] TPM Function

This product features Firmware-TPM (fTPM) v2.0. Besides, it is prepared for a hardware TPM chip which can be fitted by factory on request.

XH410G with VESA mount (drawing)

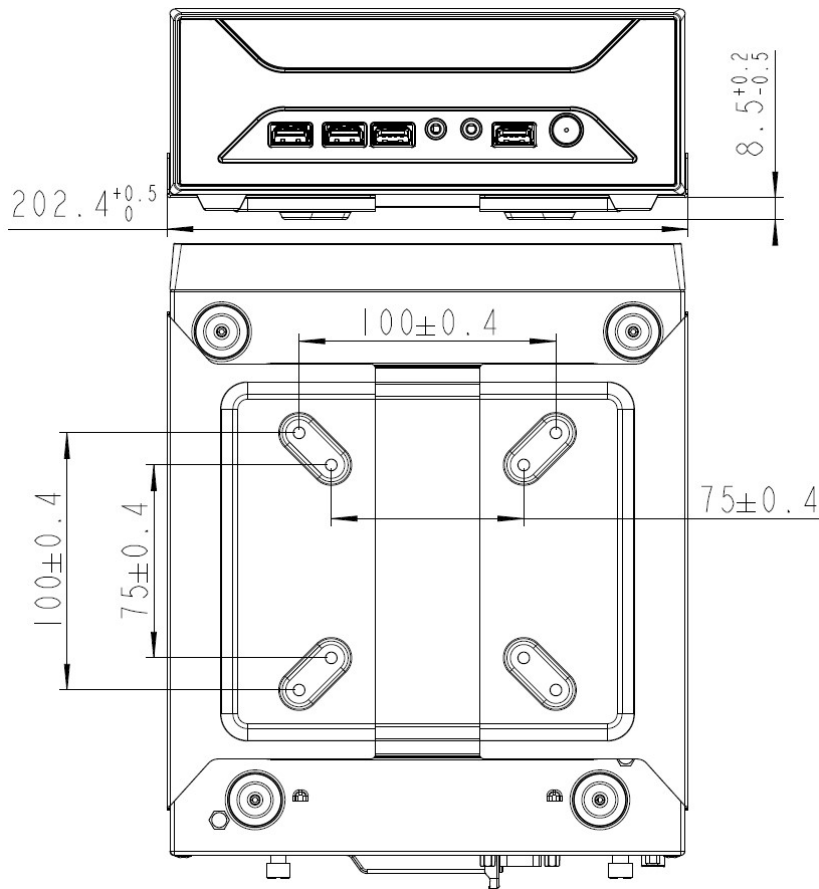

10TH GENERATION INTEL CORE DESKTOP PROCESSOR FAMILY

Socket LGA1200 14 nm "Comet Lake S" and "Comet Lake Refresh" processor overview (Date: August 2021)

Processors with a TDP of more than 65W are **not supported (marked in red)**.

PROCESSOR	MODEL	CORES/ THREADS	CPU CLOCK	TURBO BOOST 2.0	SMART CACHE	TDP	MEMORY SUPPORT	GRAPHICS ENGINE
Core™ i9	10900K	10/20	3.7 GHz	5.1 GHz	20 MB	125 W	DDR4-2933	UHD 630
	10900KF	10/20	3.7 GHz	5.1 GHz	20 MB	125 W	DDR4-2933	None
	10900	10/20	2.8 GHz	5.0 GHz	20 MB	65 W	DDR4-2933	UHD 630
	10900F	10/20	2.8 GHz	5.0 GHz	20 MB	65 W	DDR4-2933	None
	10900T	10/20	1.9 GHz	4.5 GHz	20 MB	35 W	DDR4-2933	UHD 630
	10850K	10/20	3.6 GHz	5.0 GHz	20 MB	125 W	DDR4-2933	UHD 630
Core™ i7	10700K	8/16	3.8 GHz	5.0 GHz	16 MB	125 W	DDR4-2933	UHD 630
	10700KF	8/16	3.8 GHz	5.0 GHz	16 MB	125 W	DDR4-2933	None
	10700	8/16	2.9 GHz	4.7 GHz	16 MB	65 W	DDR4-2933	UHD 630
	10700F	8/16	2.9 GHz	4.7 GHz	16 MB	65 W	DDR4-2933	None
	10700T	8/16	2.0 GHz	4.4 GHz	16 MB	35 W	DDR4-2933	UHD 630
Core™ i5	10600K	6/12	4.1 GHz	4.8 GHz	12 MB	125 W	DDR4-2666	UHD 630
	10600KF	6/12	4.1 GHz	4.8 GHz	12 MB	125 W	DDR4-2666	None
	10600	6/12	3.3 GHz	4.8 GHz	12 MB	65 W	DDR4-2666	UHD 630
	10600T	6/12	2.4 GHz	4.0 GHz	12 MB	35 W	DDR4-2666	UHD 630
	10500	6/12	3.1 GHz	4.5 GHz	12 MB	65 W	DDR4-2666	UHD 630
	10500T	6/12	2.3 GHz	3.8 GHz	12 MB	35 W	DDR4-2666	UHD 630
	10400	6/12	2.9 GHz	4.3 GHz	12 MB	65 W	DDR4-2666	UHD 630
	10400F	6/12	2.9 GHz	4.3 GHz	12 MB	65 W	DDR4-2666	None
	10400T	6/12	2.0 GHz	3.6 GHz	12 MB	35 W	DDR4-2666	UHD 630
Core™ i3	10325	4/8	3.9 GHz	4.7 GHz	8 MB	65 W	DDR4-2666	UHD 630
	10320	4/8	3.8 GHz	4.6 GHz	8 MB	65 W	DDR4-2666	UHD 630
	10305	4/8	3.8 GHz	4.5 GHz	8 MB	65 W	DDR4-2666	UHD 630
	10305T	4/8	3.8 GHz	4.5 GHz	8 MB	65 W	DDR4-2666	UHD 630
	10300	4/8	3.7 GHz	4.4 GHz	8 MB	65 W	DDR4-2666	UHD 630
	10300T	4/8	3.0 GHz	3.9 GHz	8 MB	35 W	DDR4-2666	UHD 630
	10105F	4/8	3.7 GHz	4.4 GHz	6 MB	65 W	DDR4-2666	None
	10105	4/8	3.7 GHz	4.4 GHz	6 MB	65 W	DDR4-2666	UHD 630
	10105T	4/8	3.0 GHz	3.9 GHz	6 MB	35 W	DDR4-2666	UHD 630
	10100	4/8	3.6 GHz	4.3 GHz	6 MB	65 W	DDR4-2666	UHD 630
	10100F	4/8	3.6 GHz	4.3 GHz	6 MB	65 W	DDR4-2666	None
	10100T	4/8	3.0 GHz	3.8 GHz	6 MB	35 W	DDR4-2666	UHD 630
Pentium® Gold	G6605	2/4	4.3 GHz	-	4 MB	58 W	DDR4-2666	UHD 630
	G6600	2/4	4.2 GHz	-	4 MB	58 W	DDR4-2666	UHD 630
	G6505	2/4	4.2 GHz	-	4 MB	58 W	DDR4-2666	UHD 630
	G6500	2/4	4.1 GHz	-	4 MB	58 W	DDR4-2666	UHD 630
	G6500T	2/4	3.5 GHz	-	4 MB	35 W	DDR4-2666	UHD 630
	G6405	2/4	4.1 GHz	-	4 MB	58 W	DDR4-2666	UHD 610
	G6405T	2/4	3.5 GHz	-	4 MB	35 W	DDR4-2666	UHD 610
	G6400	2/4	4.0 GHz	-	4 MB	58 W	DDR4-2666	UHD 610
	G6400T	2/4	3.4 GHz	-	4 MB	35 W	DDR4-2666	UHD 610

PROCESSOR	MODEL	CORES/ THREADS	CPU CLOCK	TURBO BOOST 2.0	SMART CACHE	TDP	MEMORY SUPPORT	GRAPHICS ENGINE
Celeron®	G5925	2/2	3.6 GHz	-	4 MB	58 W	DDR4-2666	UHD 610
	G5920	2/2	3.5 GHz	-	2 MB	58 W	DDR4-2666	UHD 610
	G5905	2/2	3.5 GHz	-	4 MB	58 W	DDR4-2666	UHD 610
	G5905T	2/2	3.3 GHz	-	4 MB	35 W	DDR4-2666	UHD 610
	G5900	2/2	3.4 GHz	-	2 MB	58 W	DDR4-2666	UHD 610
	G5900T	2/2	3.2 GHz	-	2 MB	35 W	DDR4-2666	UHD 610

K = unlocked, T = Power optimized lifestyle, F = without integrated graphics, TDP = Thermal Design Power (max. Power Consumption).

Note: The Shuttle XPC slim Barebone XH410G does not support the Unlock-function of Intel K-Series processors.
Please refer to the support list for detailed processor support information at global.shuttle.com.